

DECKING

PARKLEX PRODEMA



NATURDECK-B is a high-density composite floor for exteriors that is highly resistant to atmospheric changes in moisture and temperature.

It repels stains, mould and bacteria, so it is ideal for terraces and the area around swimming pools. It has obtained a rating of Class 3, which is the highest slip resistance rating according to the UNE-ENV 12633 standard.



Product: NATURDECK-B / Finish: Tobacco
Roof of a Hotel in Barcelona, by Daniela Hartmann
(Barcelona, Spain)

No maintenance

The surface composition of Parklex Prodema products protects against adverse weather conditions, eliminating the need for any maintenance or treatment.

Uniqueness

The texture on the surface of each NATURDECK-B panel is unique, thus no patterns are generated in composition.

Resistant to changes

Extremely resistant to atmospheric changes in humidity and temperature, it is also highly resistant to UV light, such that the colour of the material remains stable over time.

Slip resistant

NATURDECK-B exterior flooring is rated Class 3, the best possible slip resistance rating according to the UNE-ENV 12633 regulation.

Antiseptic

Due to its high density, this composite repels stains, fungus and bacteria.

PEFC certified

PEFC certified NATURDECK-B is available upon request.

Made in the European Union

Complying with European regulations, at Parklex Prodema we guarantee the quality in our manufacturing process, the safety of our employees and, of course, that of our customers.

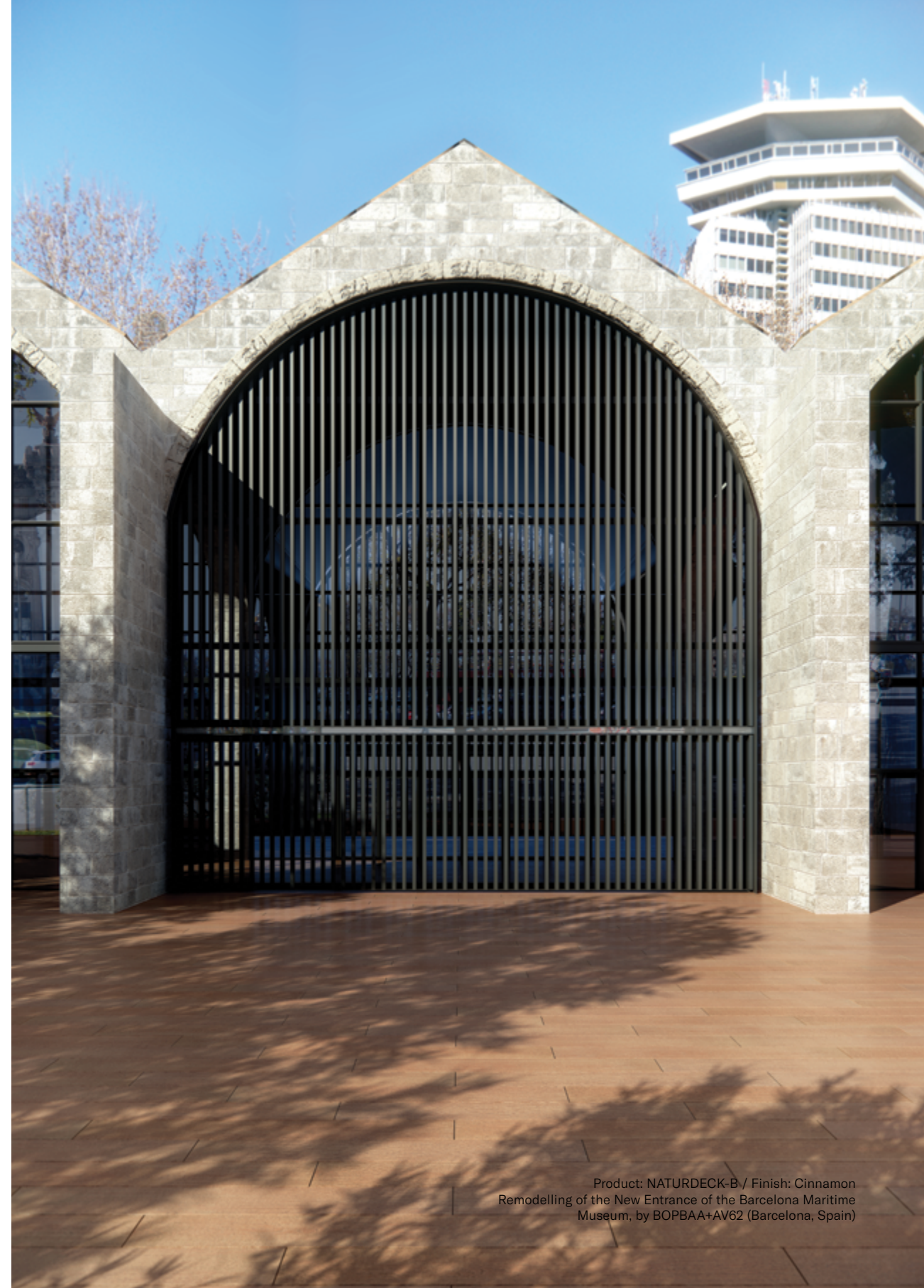



Product: NATURDECK-B / Finish: Cinnamon
Private Villa in Torri del Garda, by Rocchi Piubello Architettura
(Verona, Italy)



Product: NATURDECK-B
House in Roses, by Jordi Hidalgo i Tané (Roses, Spain)

Each board is unique. We make sure that the texture of the surface varies from one panel to another, in order to avoid repeated patterns in any composition. NATURDECK-B decking is available in 6 different finishes and 3 standard widths: 130, 198 and 300 mm.



CINNAMON



CINDER



TOBACCO

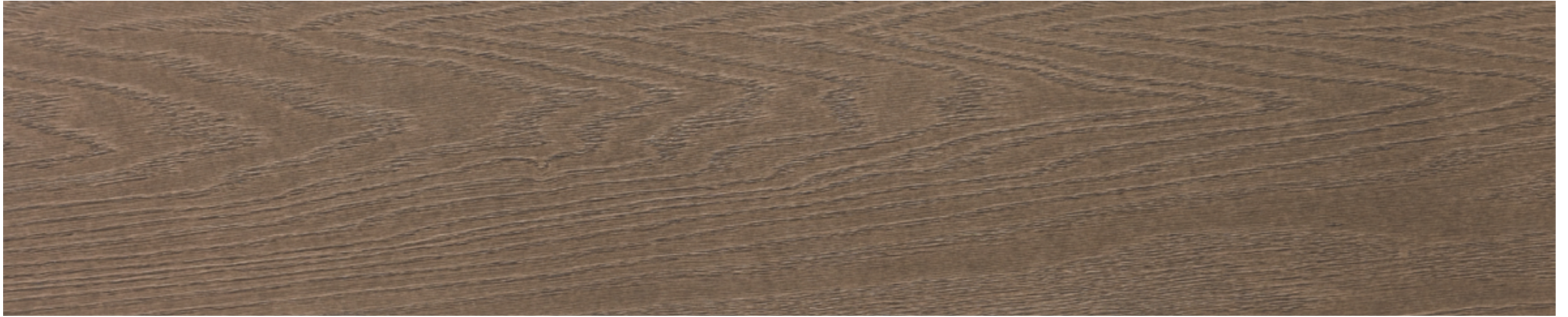

CHIA



SESAME



MUSTARD

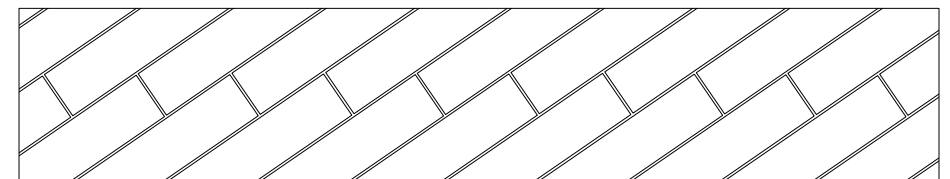
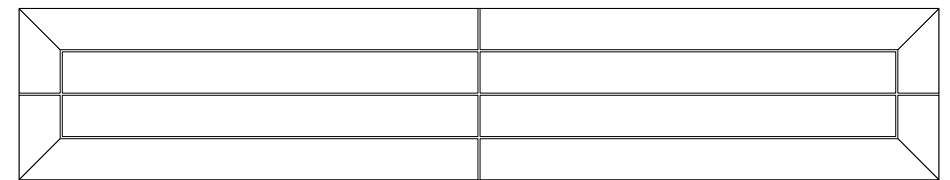
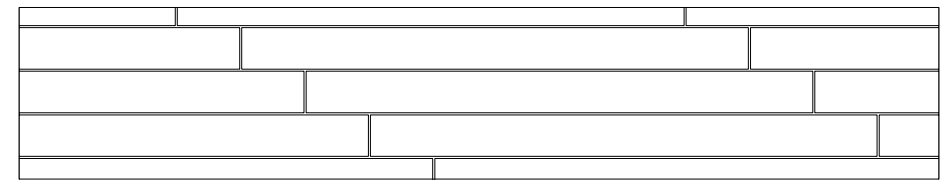
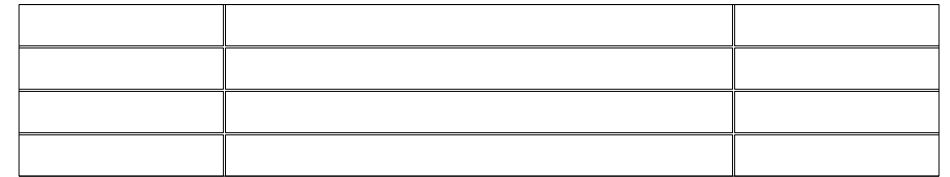

The assembly pattern must be studied before starting the work since installation of the supporting substructure will depend on the pattern used.

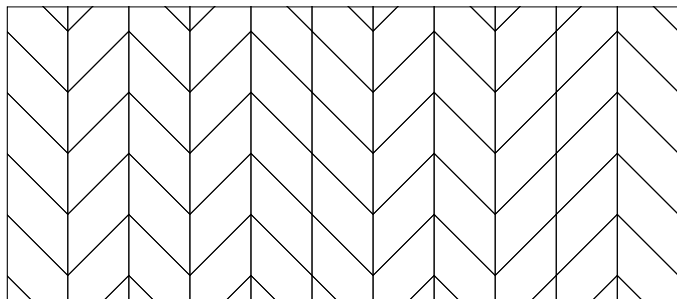
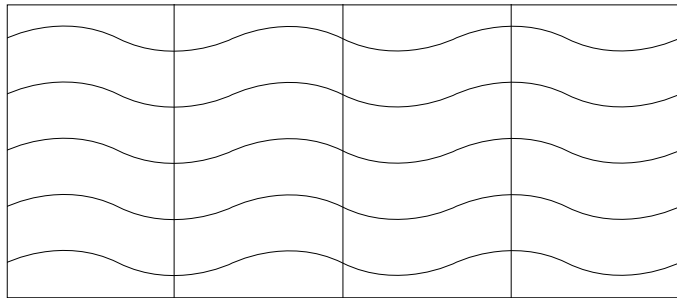
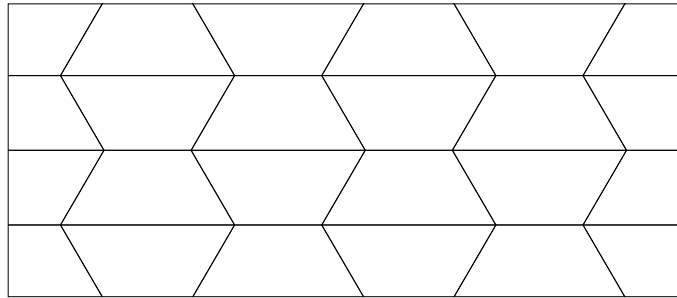

We offer the possibility of creating bespoke decking by cutting NATURDECK-B panels in both straight and curved shapes, and to combine several finishes in one composition.

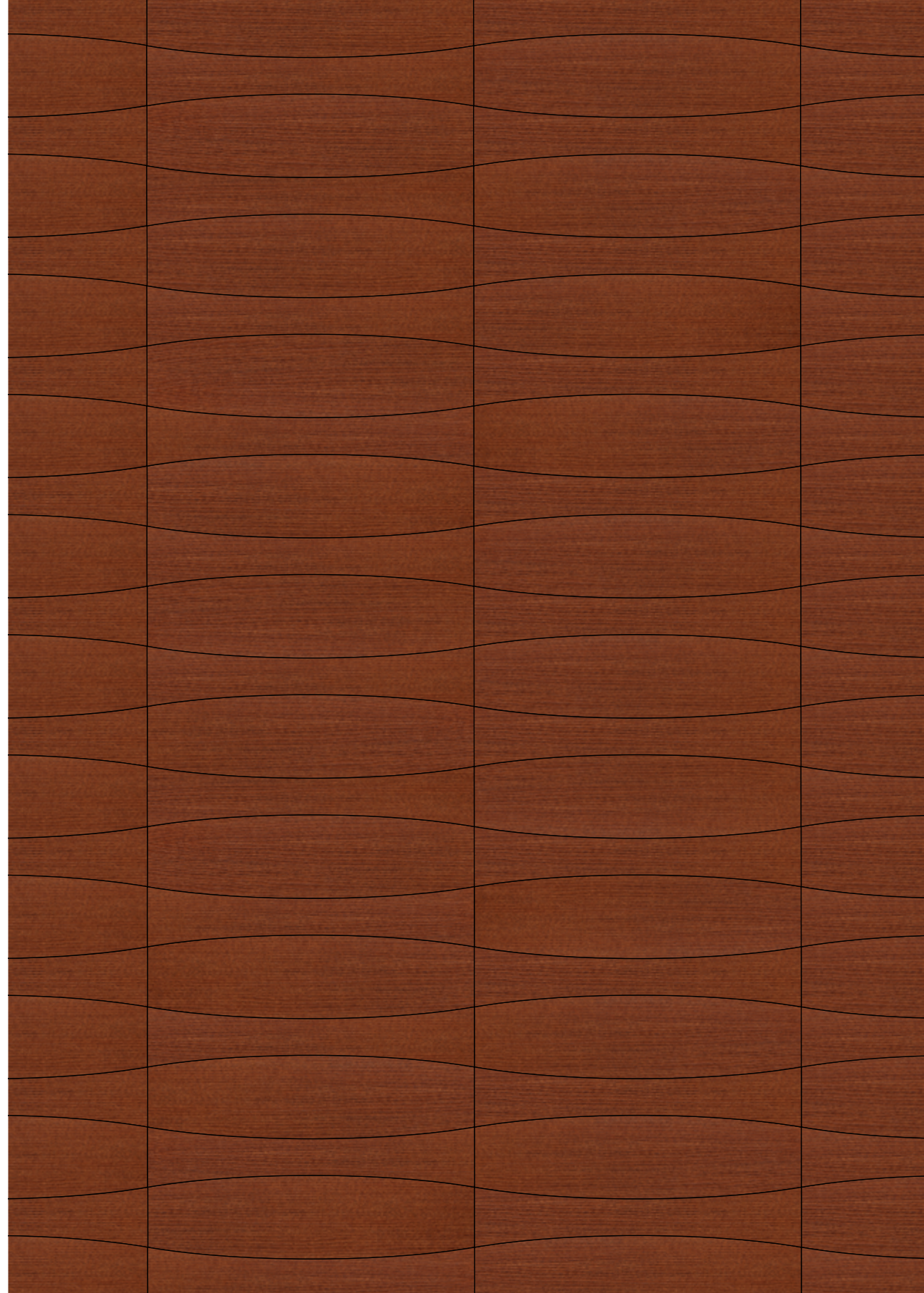



Product: NATURDECK-B / Finish: Cinder
Hotel Atalaia (Irun, Spain)

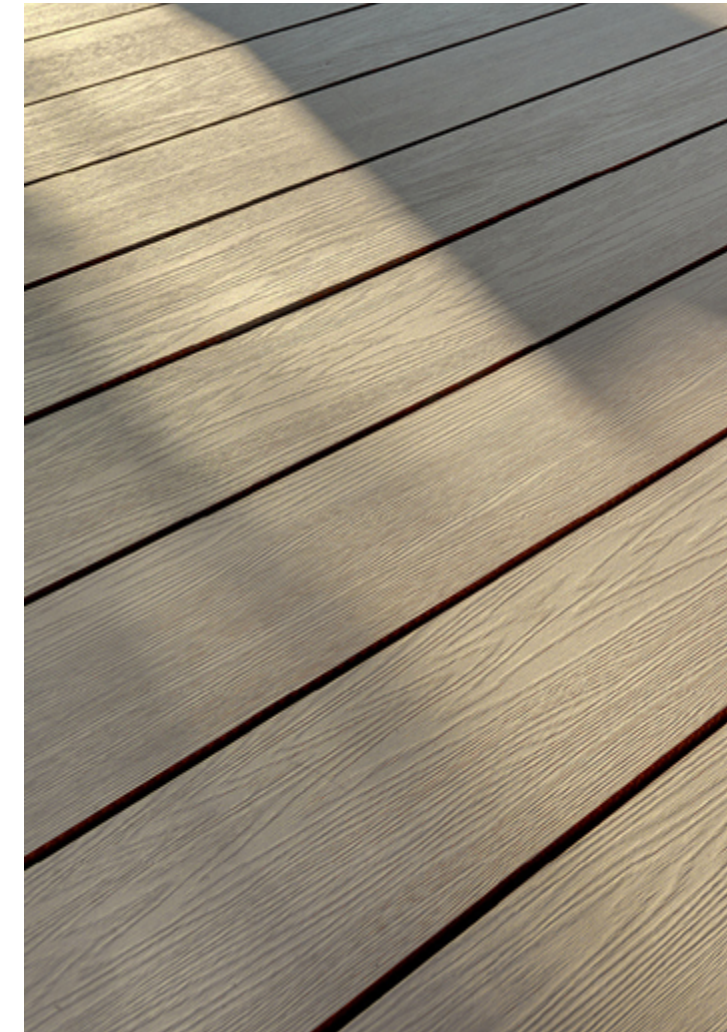

NATURDECK-B decking can be installed with screws, staples or with an adhesive system over a supporting substructure.

Perimeter expansion joints must be left at the end and along the length of the boards in order to allow them to move, freely expand or contract, and to facilitate the evacuation of water or snow.

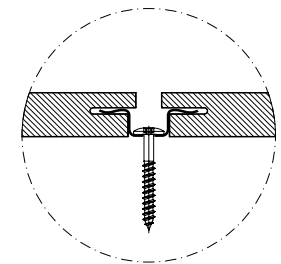
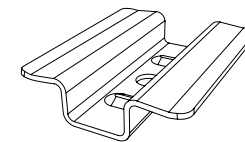
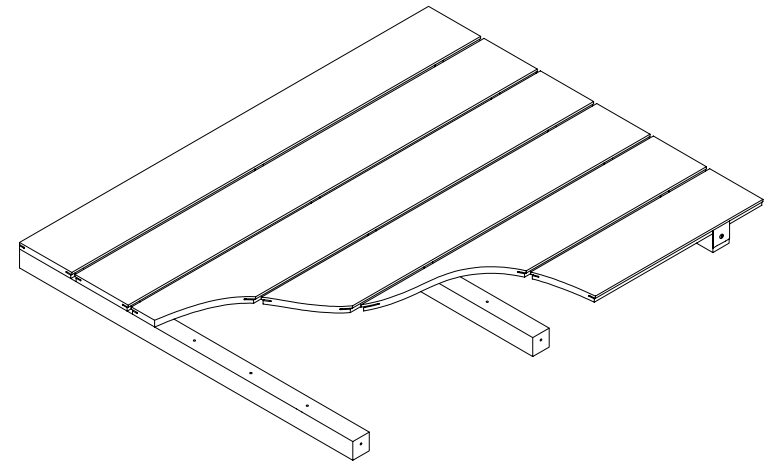

NATURDECK-B can be installed with an invisible fixation system using staples. This system is only available for 14 mm-thick boards that are supplied with their longitudinal edge machined.

When using this system, the maximum available board width is 198 mm.

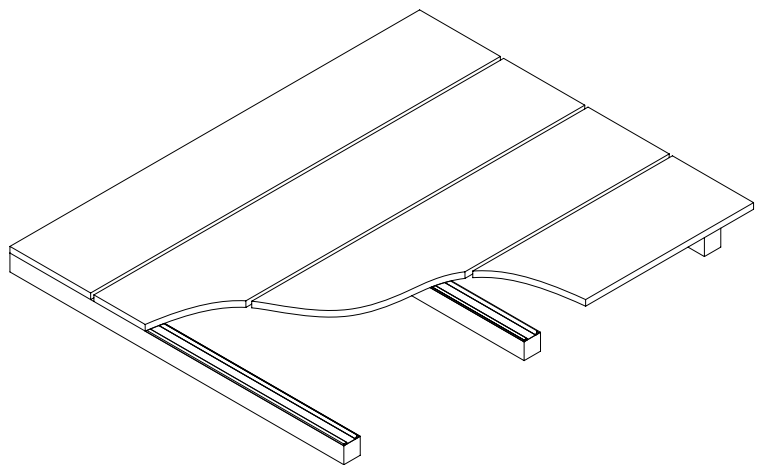

Parklex Prodema has obtained a strict and appropriate procedure for gluing NATURDECK-B panels from the adhesive manufacturer.

Given the continuous variations in adhesive design and applications, we recommend that you consult us on the most recent application procedure if you want to use this system.





To install NATURDECK-B, Parklex Prodema offers screws, staples and substructural profiles.

EDITING & PRODUCTION
PARKLEX PRODEMA

ART DIRECTION
JAUME RAMÍREZ STUDIO

TEXT
CHESCA GUIM

PHOTOGRAPHY
MARÇAL VAQUER
JARA VARELA
YOSIGO

INFOGRAPHICS
ESTUDI CREAD

PRINTED IN BARCELONA
BY AGPOGRAF

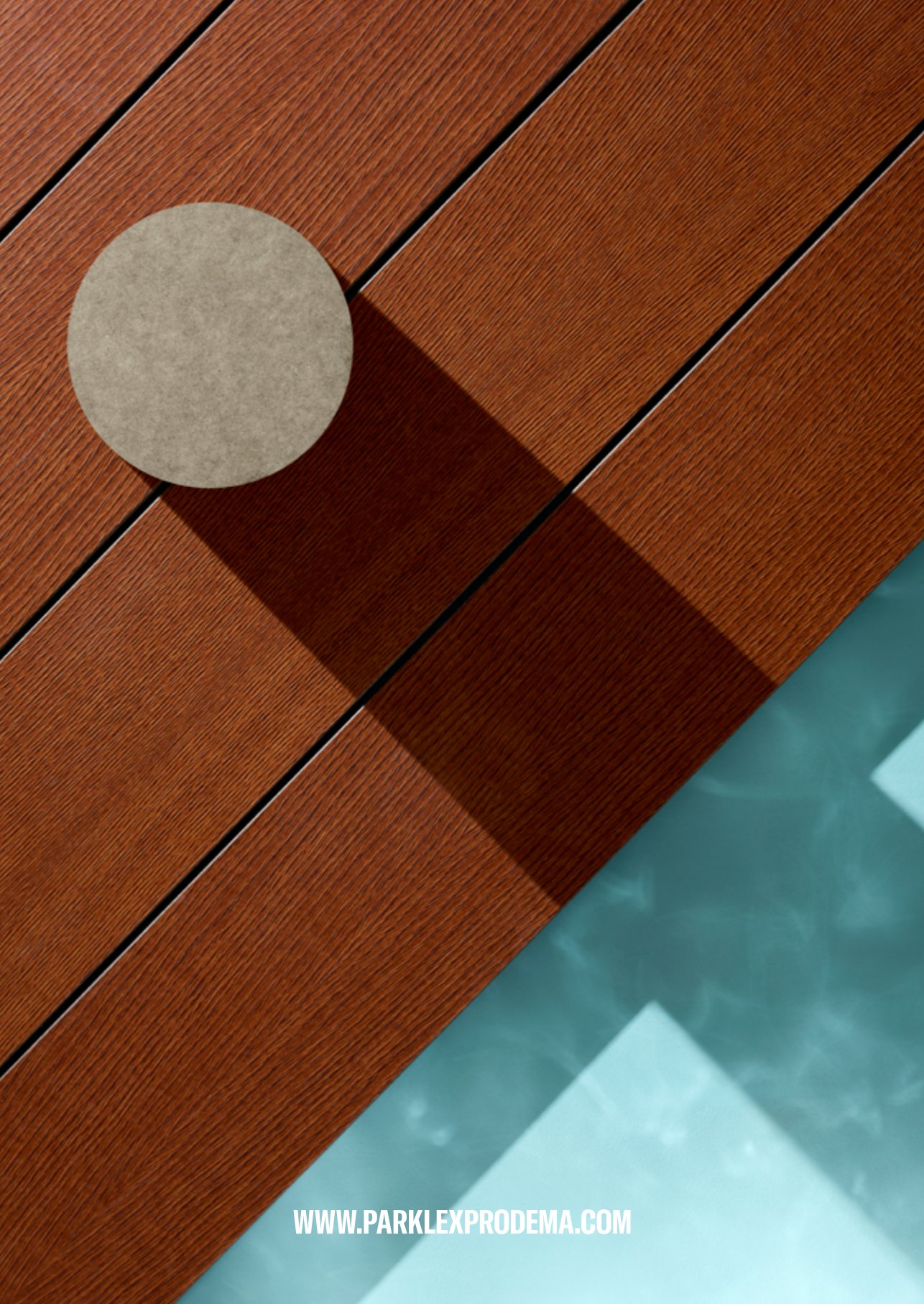

WWW.PARKLEXPRODEMA.COM